



News
2024

Hand
Made
light

el**torrent**

23

Index

Collections

- 04 CALA
- 14 MEISY
- 26 SWEET
- 30 ZIG-ZAG
- 36 SHUT UP!
- 40 EVA ACOUSTIC

Pendants *Lámparas Colgantes*

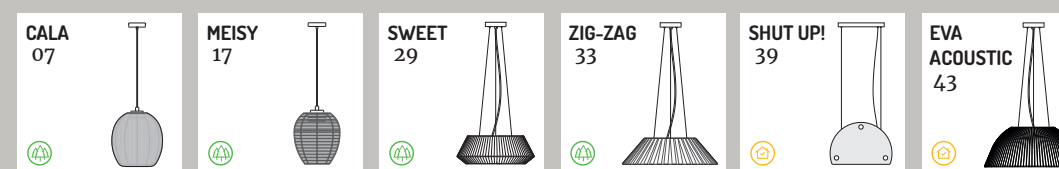

Ceiling lamps *Plafones*

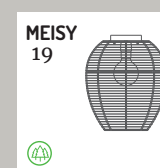

Floor lamps *Lámparas de pie*



Table lamps *Lámparas de sobremesa*

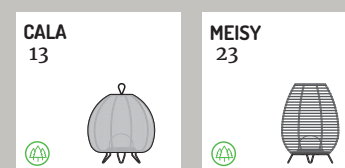



Cala

by Joan Genebat



OUTDOOR



CUSTOM











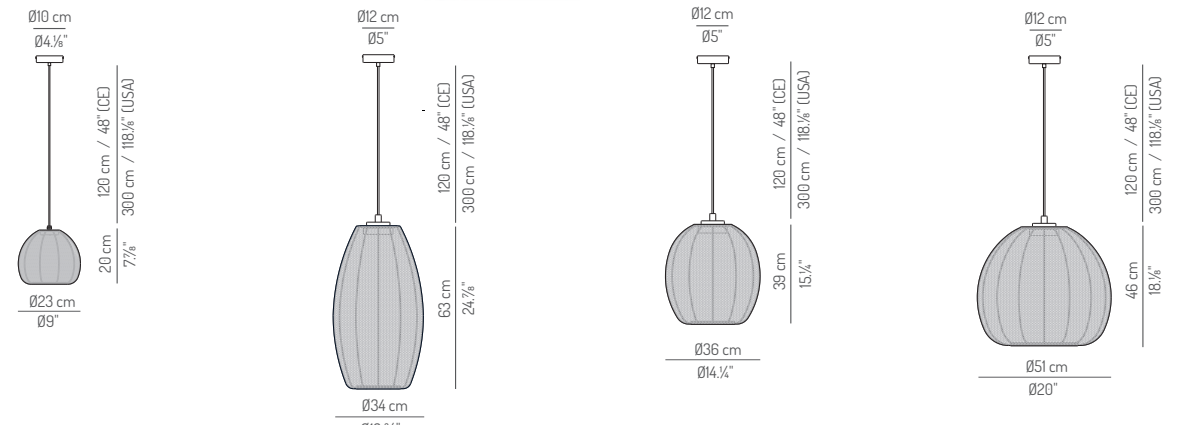



DIMMABLE





-  OUTDOOR
-  CUSTOM
-  DIMMABLE TRIAC
-  EASY TO REPLACE



- | | | | | | | | |
|--|-------------|--|-------------|--|-------------|--|-------------|
| CA.S123.14B | CA.S123.14T | CA.S134.16B | CA.S134.16T | CA.S136.16B | CA.S136.16T | CA.S151.16B | CA.S151.16T |
| CA.S123.14O | CA.S123.14A | CA.S134.16O | CA.S134.16A | CA.S136.16O | CA.S136.16A | CA.S151.16O | CA.S151.16A |
| CA.S123.14M | | CA.S134.16M | | CA.S136.16M | | CA.S151.16M | |
| LED 4,5W 500mA 2700K 750lm | | LED 15W 230V 2700K 1200lm | | LED 15W 230V 2700K 1200lm | | LED 15W 230V 2700K 1200lm | |
|   IP54 | |    IP54 | |    IP54 | |    IP54 | |

Knitted lampshade with acrylic yarn suitable for outdoors (UV-treated), washable and easy to replace. Lampshade available in five different colors. Black metal structure. Black electrical cable. Black canopy.

Pantalla tejida de punto con hilo acrílico apto para exteriores (tratamiento UV), lavable y fácilmente reemplazable. Pantalla disponible en cinco colores distintos. Estructura de metal negra. Cable y florón en negro.





Private residence
(Spain)

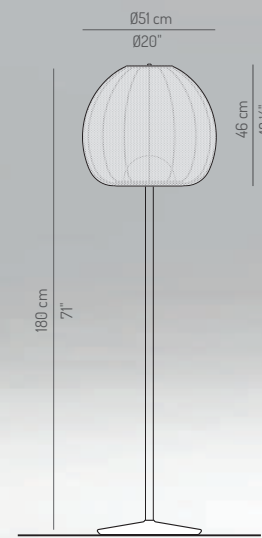

- CA.F151.16B ● CA.F151.16T
- CA.F151.16O ● CA.F151.16A
- CA.F151.16M

LED 15W 230V 2700K 1200lm



 IP65

Knitted lampshade with acrylic yarn suitable for outdoors (UV-treated), washable and easy to replace. Lampshade available in five different colors. Opal half moon acrylic diffuser. Black stainless steel post and black metal structure. Concrete base. Black electrical cable.

Pantalla tejida de punto con hilo acrílico apto para exteriores (tratamiento UV), lavable y fácilmente reemplazable. Pantalla disponible en cinco colores distintos. Difusor semiesférico de metacrilato opal. Tija de acero inoxidable en negro y estructura metálica negra. Base de hormigón. Cable eléctrico negro.





 PENDING

lampshade pantalla

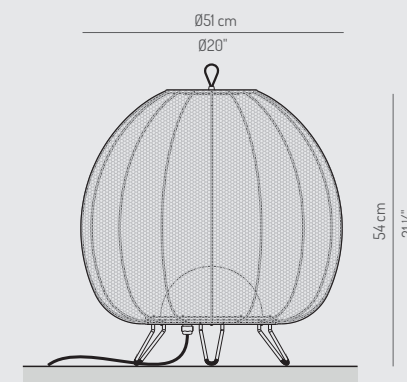
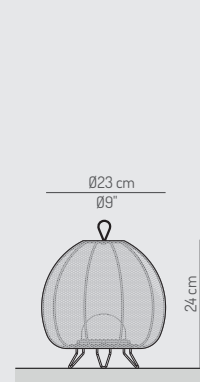

-  OUTDOOR
-  CUSTOM
-  DIMMABLE TRIAC
-  PLUG IN
-  EASY TO REPLACE



- CA.T123.15B ● CA.T123.15T
- CA.T123.15O ● CA.T123.15A
- CA.T123.15M

LED 3W 3000K 290lm



Knitted lampshade with acrylic yarn suitable for outdoors (UV-treated), washable and easy to replace. Lampshade available in five different colors. Opal half moon acrylic diffuser. Black metal structure. Table lamp with rechargeable battery. Black acrylic cord handle.

- CA.B151.16B ● CA.B151.16T
- CA.B151.16O ● CA.B151.16A
- CA.B151.16M

LED 15W 230V 2700K 1200lm



Pantalla tejida de punto con hilo acrílico apto para exteriores (tratamiento UV), lavable y fácilmente reemplazable. Pantalla disponible en cinco colores distintos. Difusor semiesférico de metacrilato opal. Estructura metálica negra. Lámpara de mesa con sistema LED recargable. Asa de cordón negro acrílico.



OUTDOOR



CUSTOM



BATTERY



DIMMABLE PUSH



DIMMABLE TRIAC



PLUG IN



EASY TO REPLACE



PENDING

lampshade pantalla





14 Meisy

El Torrent



El Torrent

Meisy

by Eloy Puig



Meisy 15



INDOOR



OUTDOOR



CUSTOM



DIMMABLE TRIAC*

MY.S030.00

1xE27 LED Globe G95 12W



*IP20

MY.S130.00

1xE27 LED Globe G95 12W



*IP65

MY.S130.16

LED 15W 230V 2700K 1200lm



IP54

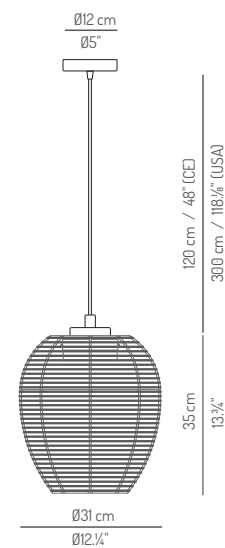

Available in one, two or three colors
 Disponible en uno, dos o tres colores

MY.S046.00

1xE27 LED Globe G120 15W



*IP20

MY.S146.00

1xE27 LED Globe G120 15W



*IP65

MY.S146.16

LED 15W 230V 2700K 1200lm



IP54

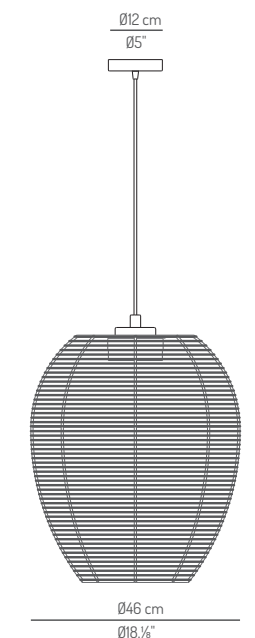

Available in one, two, three or four colors
 Disponible en uno, dos, tres o cuatro colores

Braided natural or acrylic cord shade (see finishes in general catalogue). Black metal structure. Black electrical cable. Black canopy.

Pantalla de cordón trenzado acrílico o natural (acabados consultar catálogo general). Estructura metálica negra. Cable eléctrico negro. Florón negro.



Dimmable when using dim. lamps *



-  INDOOR
-  OUTDOOR
-  CUSTOM
-  DIMMABLE TRIAC*

MY.P030.00

1xE27 LED Globe G95 12W

- 
- 
-  IP20

MY.P130.00

1xE27 LED Globe G95 12W

- 
- 
-  IP65

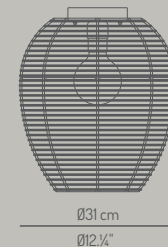

Available in one, two or three colors
 Disponible en uno, dos o tres colores

MY.P046.00

1xE27 LED Globe G120 15W

- 
- 
-  IP20

MY.P146.00

1xE27 LED Globe G120 15W

- 
- 
-  IP65

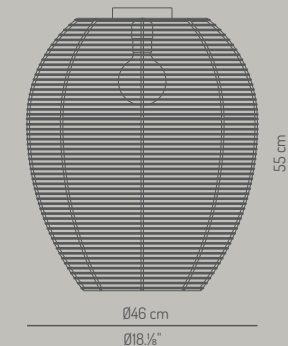

Available in one, two, three or four colors
 Disponible en uno, dos, tres o cuatro colores

Braided natural or acrylic cord shade (see finishes in general catalogue). Black metal structure. Black canopy.

Pantalla de cordón trenzado acrílico o natural (acabados consultar catálogo general). Estructura metálica negra. Florón negro.



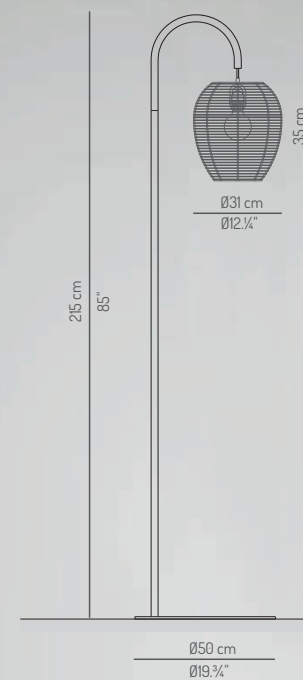

MY.F130.00

1xE27 LED Globe G95 12W

OUTDOOR CUSTOM DIMMABLE TRIAC* PLUG IN IP65

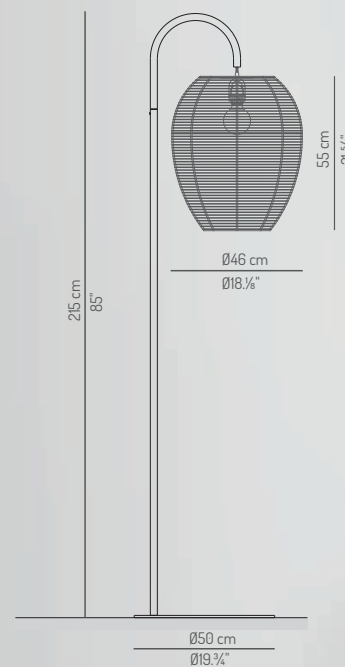

MY.F146.00

1xE27 LED Globe G120 15W

OUTDOOR CUSTOM DIMMABLE TRIAC* PLUG IN IP65

Braided natural or acrylic cord shade (see finishes in general catalogue). Black stainless steel post and black metal structure and base. Black electrical cable.

Pantalla de cordón trenzado acrílico o natural (acabados consultar catálogo general). Poste de acero inoxidable en negro y estructura metálica y base negra. Cable eléctrico negro.



Dimmable when using dim. lamps *





-  OUTDOOR
-  CUSTOM
-  BATTERY
-  DIMMABLE PUSH
-  DIMMABLE TRIAC
-  PLUG IN

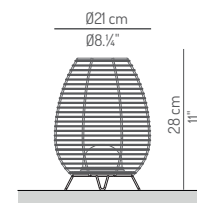

MY.T121.15

LED 3W 3000K 290lm
    IP65

Available in one, two or three colors
Disponible en uno, dos o tres colores

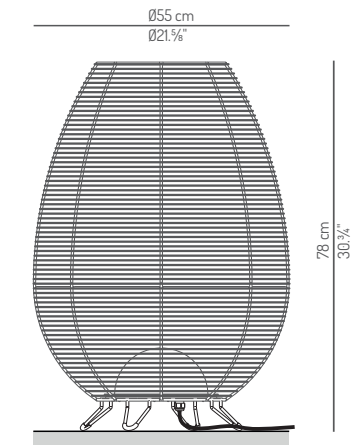

MY.F155.16

LED 15W 230V 2700K 1200lm
    IP65

Available in one, two, three or four colors
Disponible en uno, dos, tres o cuatro colores

Braided natural or acrylic cord shade (see finishes in general catalogue).
 Black metal structure. Black electrical cable.
 Table lamp with rechargeable battery operated.

Pantalla de cordón trenzado acrílico o natural (acabados consultar catálogo general)
 Estructura metálica negra. Cable eléctrico negro.
 Lámpara de mesa con sistema LED recargable.







Sweet

by Eloy Puig



OUTDOOR



CUSTOM



DIMMABLE





OUTDOOR



CUSTOM



DIMMABLE
TRIAC

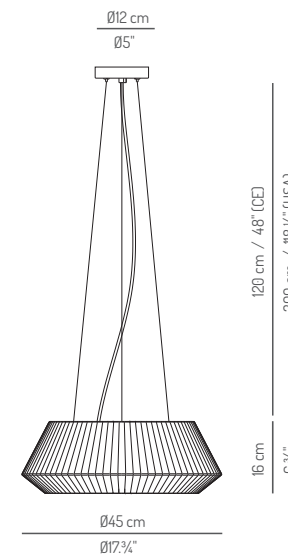

ST.S145.16

LED 15W 230V 2700K 1200lm

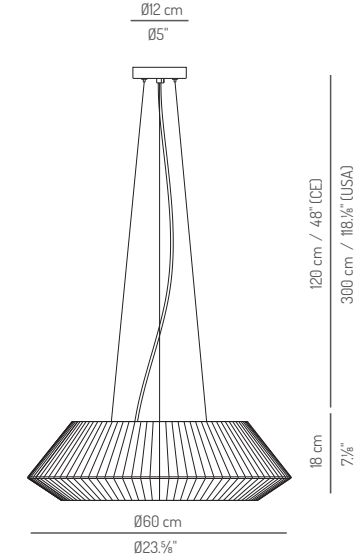

ST.S160.16

LED 15W 230V 2700K 1200lm



MATERIAL Outdoor ribbon



Acrylic ribbon shade suitable for outdoor use.
Opal half moon acrylic diffuser. Black electrical
cable. Black canopy.

Pantalla con cinta acrílica adecuada para uso en
exteriores. Difusor semiesférico de metacrilato opal.
Cable eléctrico negro. Florón negro.





Zig-Zag

by Eloy Puig



OUTDOOR CUSTOM DIMMABLE

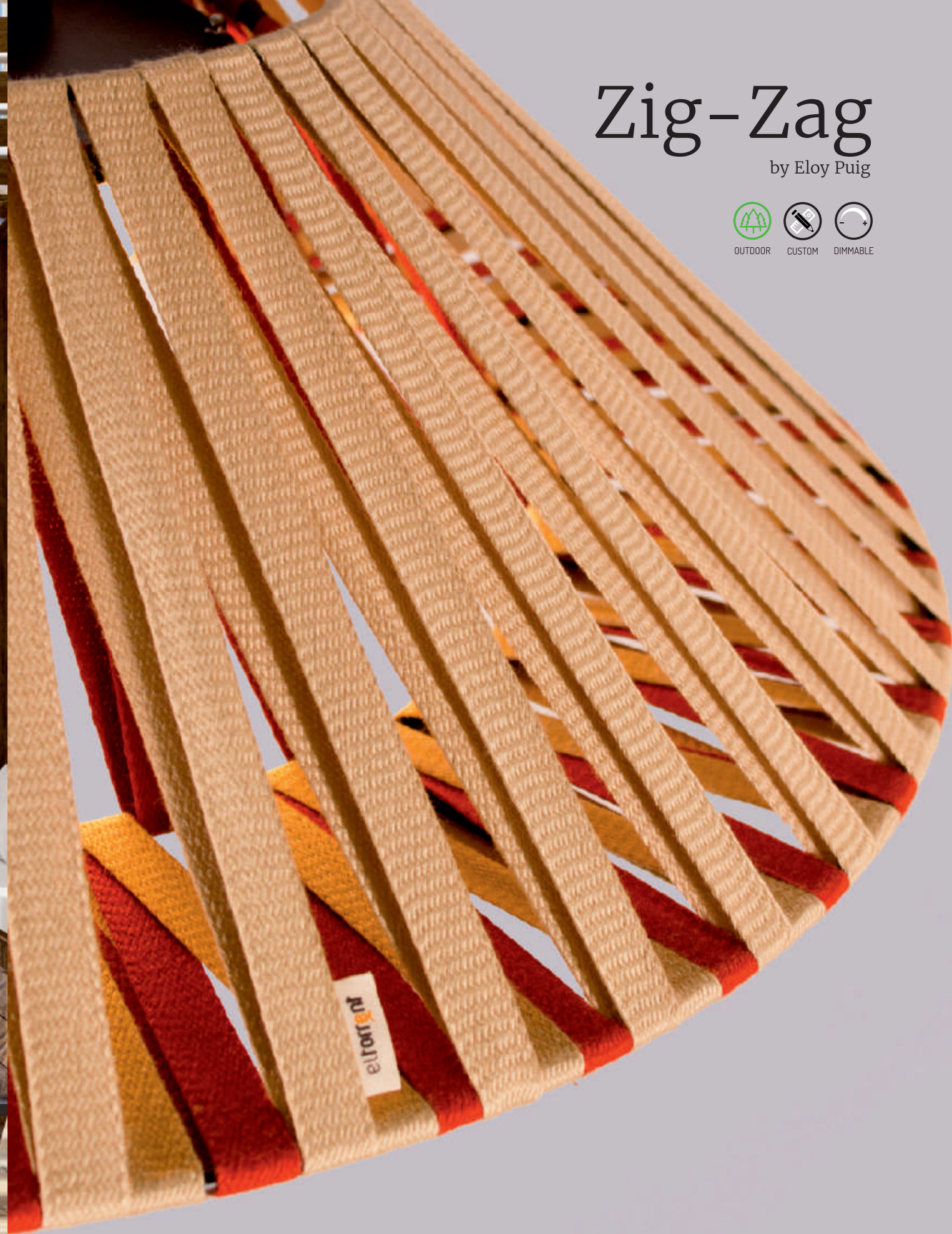

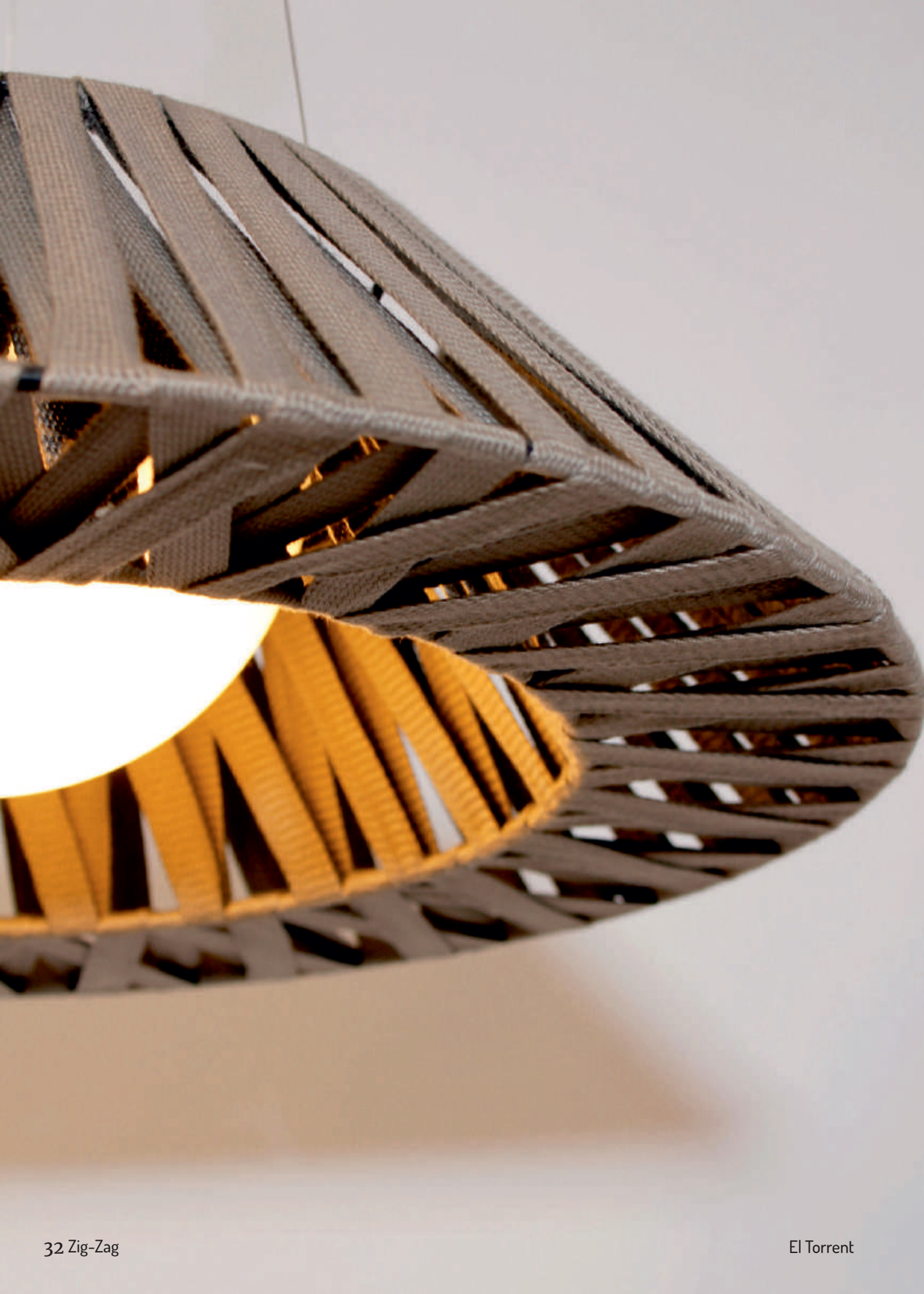

-  OUTDOOR
-  CUSTOM
-  DIMMABLE TRIAC

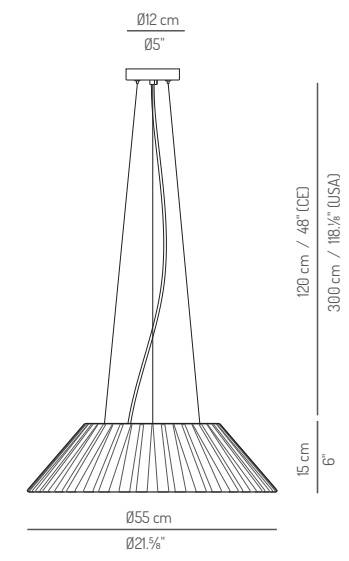

ZZ.S155.16
 LED 15W 230V 2700K 1200lm
 IP54

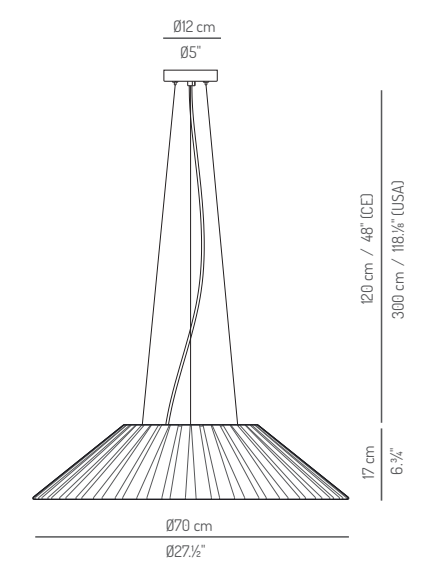

ZZ.S170.16
 LED 15W 230V 2700K 1200lm
 IP54

Available in one or two colors
 Disponible en uno o dos colores

MATERIAL Outdoor ribbon



Acrylic ribbon shade suitable for outdoor use. Opal half moon acrylic diffuser. Black electrical cable. Black canopy.

Pantalla con cinta acrílica adecuada para uso en exteriores. Difusor semiesférico de metacrilato opal. Cable eléctrico negro. Florón negro.







Shut up!

by Joan Genebat





INDOOR



ACOUSTIC



CUSTOM



DIMMABLE TRIAC

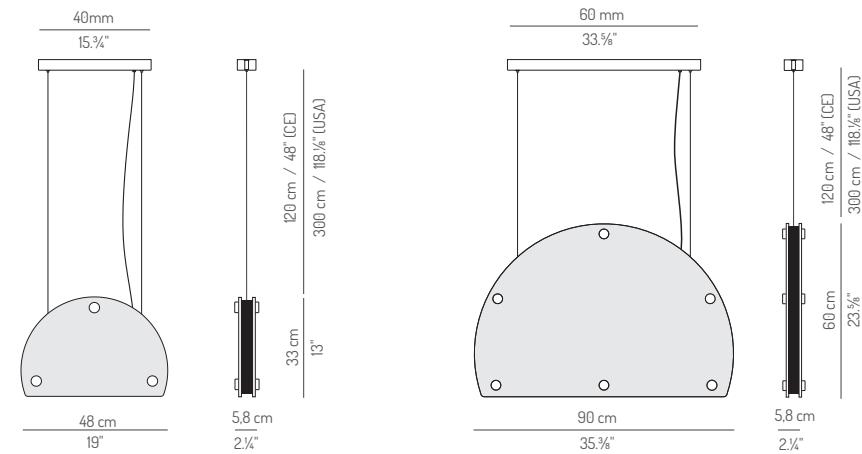

SH.S048.16B

SH.S048.16G

LED 7.4W 24V 3000K 950lm



SH.S090.16B

SH.S090.16G

LED 15W 24V 3000K 1900lm



MATERIAL Acoustic panel Panel acústico



Minimum order required
Pedido mínimo requerido

Thickness panel: 9 mm

Composition: 100% PET

Fire resistance: B-s2, do

Acoustic absorption panel: Up to $\alpha_w = 0,90$ (-)

Shade with acoustic panels available in various colors. Beech wood structure with a black lacquered metal frame. LED lighting system with opal acrylic diffuser. Black electrical cable. Black canopy.

Pantalla con paneles acústicos disponibles en varios colores. Estructura en madera de haya con un marco de metal lacado en negro. Sistema de iluminación LED con difusor acrílico opal. Cable eléctrico negro. Florón negro.





Eva acoustic

by Eloy Puig





INDOOR



ACOUSTIC



CUSTOM



DIMMABLE
TRIAC

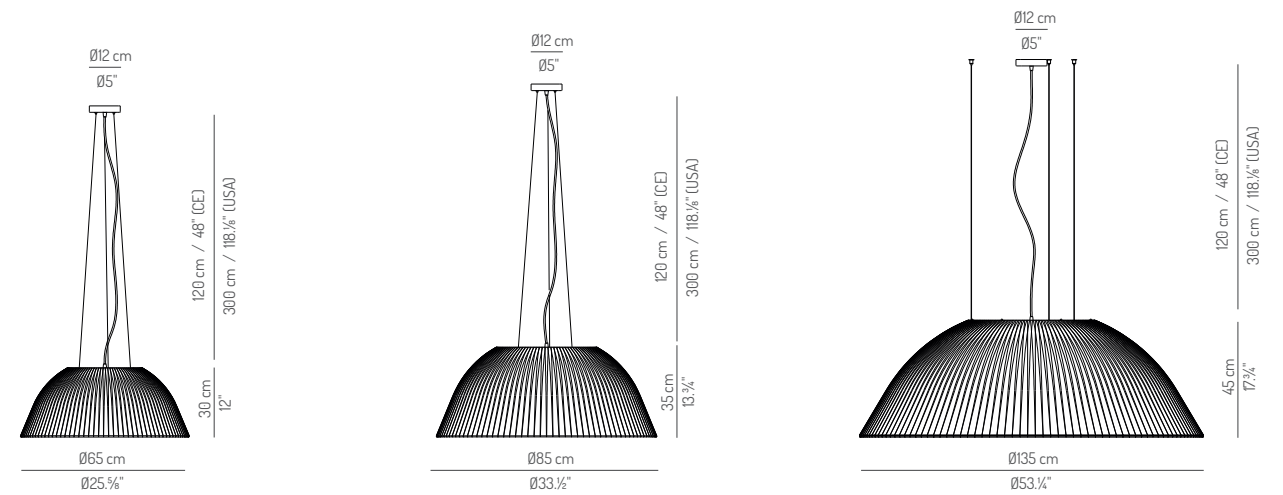

EV.065.16C

LED 24W 230V 2700K 1500lm



IP20

EV.085.16C

LED 32W 230V 2700K 2000lm



IP20

EV.135.16C

LED 56W 230V 2700K 3500lm



IP20

MATERIAL Acoustic ribbon



Thickness ribbon: 1,75 mm

Composition: 100% PET

Fire resistance: B-s1, do

Acoustic absorption ribbon: $\alpha_w = 0,15$

Acoustic ribbon shade. Acrylic dome.
Opal half moon acrylic diffuser.
Clear electrical cable. Nickel canopy.

Pantalla con cinta acústica. Estructura de
metacrilato. difusor semiesférico de metacrilato opal.
Cable eléctrico transparente. Florón níquel.



All El Torrent Il·luminació, sl. products are manufactured according to European regulations UNE-EN 60598-1:2015

The major part of collection is ETL listed.

El Torrent Il·luminació, sl. reserves the right to make any changes it believes are beneficial to the end product and are in the client's interests. The content of this catalogue is copyright protected.

The total or partial reproduction of the images, text, illustrations, and graphic designs included in this catalogue is categorically forbidden without the express authorisation of El Torrent Il·luminació, sl.

Todos los productos de El Torrent Il·luminació, S.L. están fabricados siguiendo las normativas europeas UNE-EN 60598-1:2015

La mayoría de colecciones cumplen la normativa ETL

El Torrent Il·luminació, S.L. se reserva el derecho de hacer los cambios que considere oportunos en beneficio del producto final y del cliente. Todo el contenido de este catálogo está protegido por derechos de autor y copyright.

Queda terminantemente prohibida la reproducción total o parcial de las imágenes, textos, ilustraciones y conceptos gráficos sin autorización expresa de El Torrent Il·luminació, S.L.



Design *Diseño*

www.studidf.com

Photography *Fotografía*

starpestudi.com / [@daiapuig](https://www.instagram.com/daiapuig)

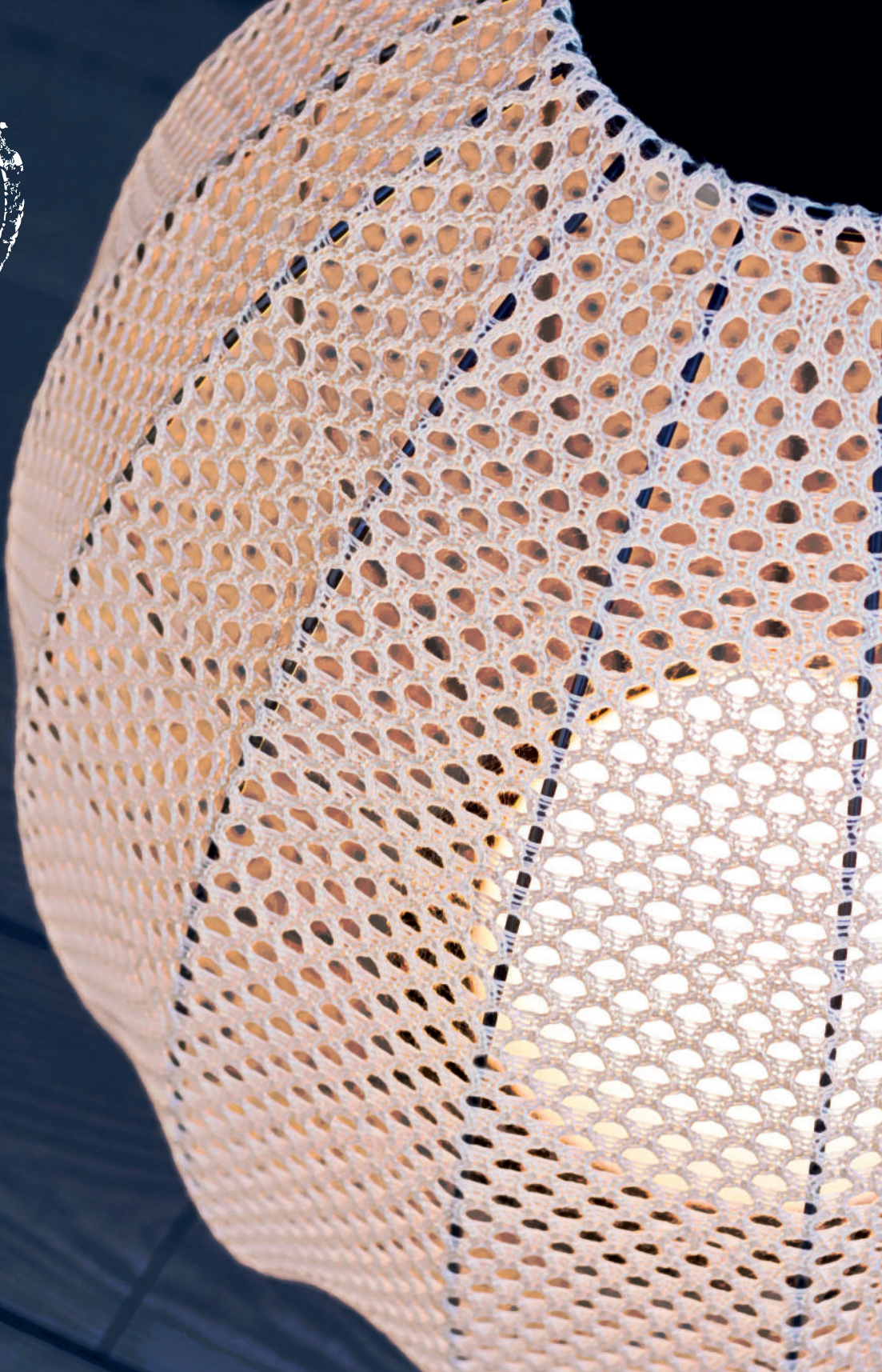

el torrent

EL TORRENT IL·LUMINACIÓ
Carreró,8. 17830 Mieres, Girona. Spain
T.+34 972 682 037 T.+34 972 680 291

www.eltorrent.com eltorrent@eltorrent.com